

When completed, this modular design has a lot of open area and is amazingly sturdy.

Please send any comment to <winson\_chan@spectrumsignal.com>.

Feel free to make copies and distribute.

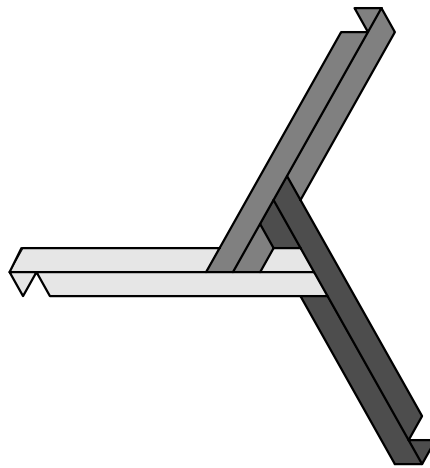
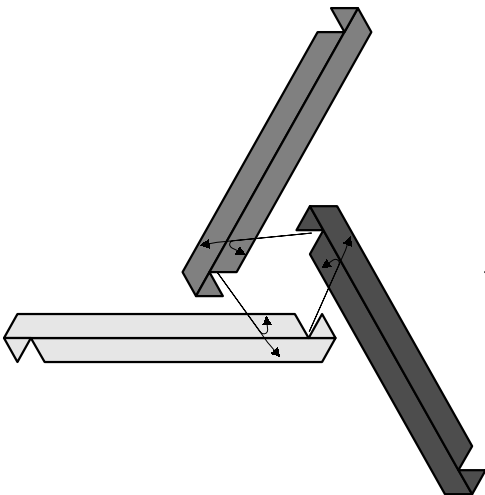
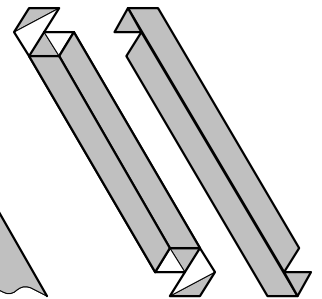
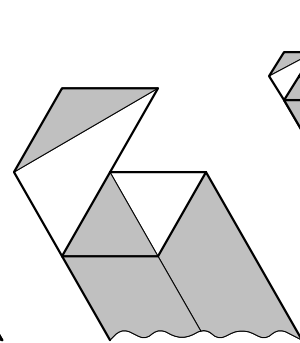
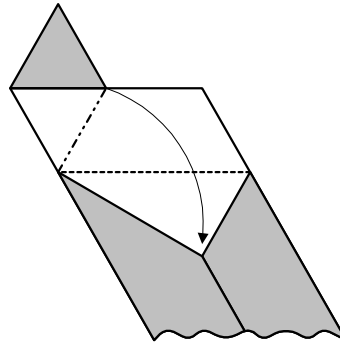
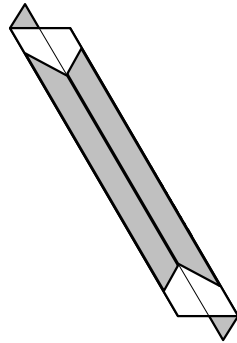
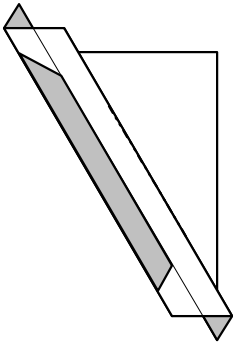
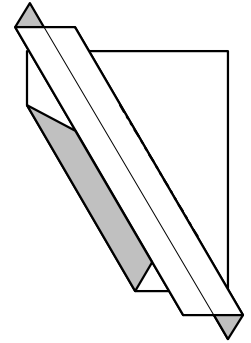
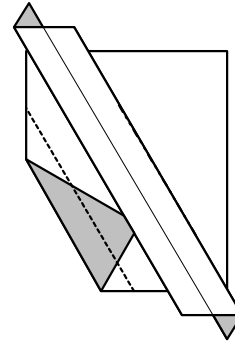
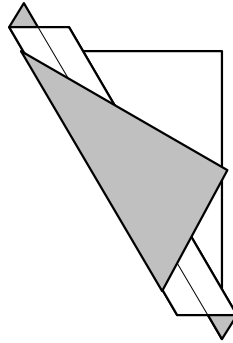
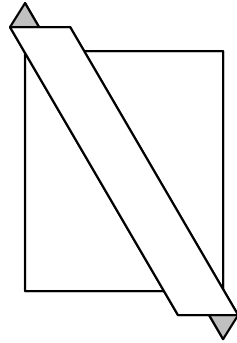
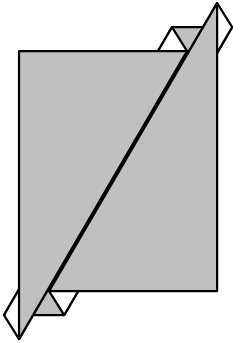
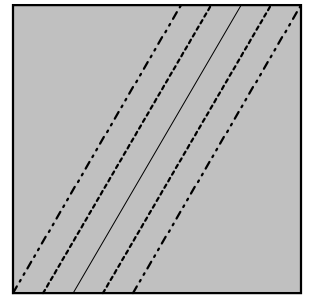
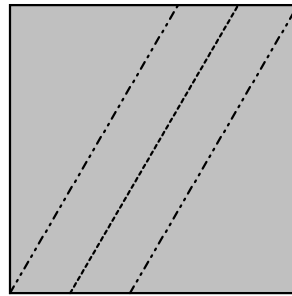
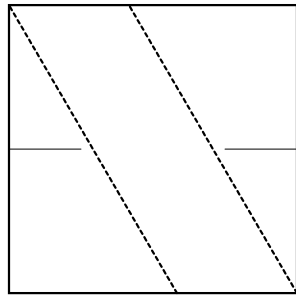
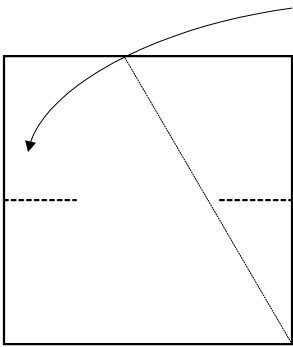

30 units required to make the structure shown below.

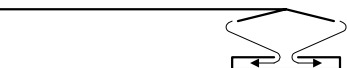
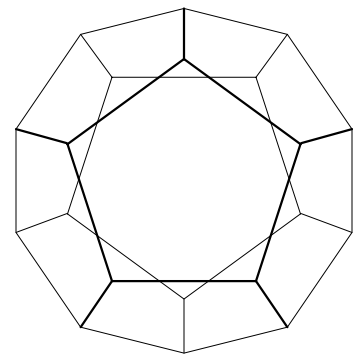

Angled Modular (Hacky Sack)	1/1
Designer: Winson Chan	
Diagrammed by: Winson Chan	
Revision: 1.0	Date: 5/15/96